

Dräger X-am[®] 5000

approved as type MQG 00xx

Multi-Gas Monitor

Technical Manual



Content

For Your Safety	4
Safety symbols used in these Technical Manual	4
Intended Use	5
Tests and Approvals	6
Marking	6
Intended operating area and operating conditions	7
Safety instructions	7
What is What	9
Front panel	9
Rear panel	9
Display	9
Special symbols	10
Configuration	11
Standard gas configuration	11
Standard device configuration	12
Activating the Device	13
Operation	14
Switching on the device	14
Switching off the device	14
Before entering the workplace	14
During operation	15
Calling the Info Mode	16
Calling the Info-Off Mode	16
Calling the Quick Menu	17
Possible functions of the quick menu	17
Quick menu "Displaying and deleting peak values"	17
Calling the Calibration Menu	18
Calibration menu functions	19
Identifying Alarms	20
Concentration pre-alarm A1	20
Concentration main alarm A2	20
STEL / TWA exposure alarm	21
Battery pre-alarm	21
Battery main alarm	21
Device alarm	21
Operation with pump	22
With Dräger Pump X-am 1/2/5000	22
With manual pump adapter and rubber ball pump	22
Observe the following during measuring mode with pump	22
Configuring the Device	23

Read Database and Display Graphically	24
Faults, Cause and Remedy	25
Warning messages	25
Fault messages	28
Maintenance	32
Maintenance intervals	32
Carrying Out the Function Test with Gas (Bump Test)	33
Manual implementation without the documentation of results in the device memory	33
Menu implementation with the documentation of results in the device memory ..	34
Automatic implementation with the Bump Test Station	36
Calibrating the Device	38
Carrying out the fresh air calibration	39
Carrying out 1-button calibration	41
Calibrating the sensitivity for an individual measuring channel	43
Sensitivity calibration for CatEx	44
Replacing the batteries / rechargeable batteries	47
Charging the rechargeable batteries	48
Charging with the multiple charging station	48
Charging with charging module and plug-in power pack or vehicle charging adapter	50
Replacing the Sensors	51
Sensor warm-up acceleration	53
Care	55
Disposing of the Device	56
Technical Data	57
X-am 5000	57
Sensor Data	57
Order List	59
Accessories	60
Spare parts	61
Declaration of Conformity	62

For Your Safety

Strictly follow the Instructions for Use

Any use of the device requires full understanding and strict observation of the Instructions for Use supplied with the device. The device is only to be used for the purposes specified here.

Maintenance

The maintenance intervals and measures stated in this Technical Handbook as well as the specifications in the Instructions for Use/data sheets of the DrägerSensors¹⁾ used must be observed. Repairs to the device may only be carried out by trained service personnel.

Accessories

Do not use accessory parts other than those included in the Order List.

Safe coupling with electrical devices

Devices which are not mentioned in the Instructions for Use or in this Technical Manual can only be coupled electronically after consultation with the manufacturers or an expert.

Use in areas subject to explosion hazards

Devices or components for use in explosion-hazard areas which have been tested and approved according to national, European or international Explosion Protection Regulations may be used only under the conditions explicitly specified in the approval and with consideration of the relevant legal regulations. The device or components may not be modified in any manner. The use of faulty or incomplete parts is forbidden. The appropriate regulations must be observed at all times when carrying out repairs on these devices or components.

Safety symbols used in these Technical Manual

These Technical Manual contain a number of warnings for risks and hazards which might occur when using the device. These warnings contain signal words to alert you to the degree of hazard you may encounter. These signal words and corresponding hazards are as follows:

DANGER

Indicates an immediate hazardous situation which, if not avoided, could result in death or serious injury.

1) The Instructions for Use/data sheets of the DrägerSensors are supplied with the device on CD. See also attached Instructions for Use and Data Sheets of the sensors used. The Instructions for Use/data sheets of the sensors used can also be downloaded from the following Internet address: www.draeger.com

⚠ WARNING

Indicates a potential hazardous situation which, if not avoided, could result in death or serious injury.

⚠ CAUTION

Indicates a potential hazardous situation which, if not avoided, could result in injury or damage to property.
Can also be used to warn against any wanton actions.

NOTICE

Additional information on the use of the device.

Intended Use

Portable gas detection instrument for the continuous monitoring of the concentration of several gases in the ambient air within the working area and in explosion-hazard areas.

X-am 5000, depending on the device type and configuration of DrägerSensors: independent measurement of one up to five gases.

Tests and Approvals

Marking

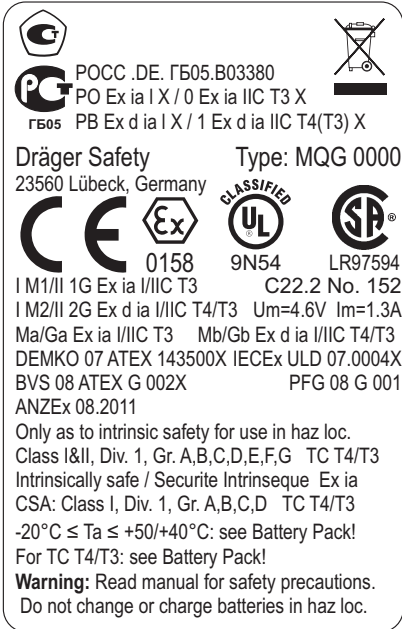

The marking information is contained within a rectangular border and includes the following elements:

- CE Marking:** POCC .DE. Г505.B03380, PO Ex ia I X / 0 Ex ia IIC T3 X, Г505 PB Ex d ia I X / 1 Ex d ia IIC T4(T3) X
- Dräger Safety:** Type: MQG 0000, 23560 Lübeck, Germany
- Classification:** CLASSIFIED
- UL Marking:** 0158, 9N54, LR97594
- SA Marking:** LR97594
- ATEX/IECEx Approvals:** I M1/II 1G Ex ia I/IIC T3, C22.2 No. 152, I M2/II 2G Ex d ia I/IIC T4/T3, Um=4.6V Im=1.3A, Ma/Ga Ex ia I/IIC T3, Mb/Gb Ex d ia I/IIC T4/T3, DEMKO 07 ATEX 143500X, IECEx ULD 07.0004X, BVS 08 ATEX G 002X, PFG 08 G 001, ANZEx 08.2011
- Safety Text:** Only as to intrinsic safety for use in haz loc. Class I&II, Div. 1, Gr. A,B,C,D,E,F,G TC T4/T3. Intrinsically safe / Securite Intrinseque Ex ia. CSA: Class I, Div. 1, Gr. A,B,C,D TC T4/T3. -20°C ≤ Ta ≤ +50/+40°C: see Battery Pack! For TC T4/T3: see Battery Pack!
- Warning:** **Warning:** Read manual for safety precautions. Do not change or charge batteries in haz loc.

Power pack 83 18 703; approved as type ABT 0000

Temperature class T4
-20 °C ≤ Ta ≤ +50 °C
use with alkaline batteries
Energizer No. E91
Energizer No. EN91 (industrial)
Varta Type 4006
Varta Type 4106 (power one)

Temperature class T3
-20 °C ≤ Ta ≤ +40 °C
use with NiMH rechargeable batteries
GP 180AAHC (1800 mAh)

Power pack 83 18 704; approved as HBT 0000

Temperature class T4
-20 °C ≤ Ta ≤ +50 °C

Serial no.¹⁾ on separate sticker

Approval Certificates

The Approval Certificates can be found on the CD supplied with the device.

WARNING

Read the safety measures in the Instructions for Use.
Do not replace or charge batteries in potentially explosive areas. Danger of explosion!

1) The year of construction is coded by the third capital letter of the serial number: T = 2003, U = 2004, W = 2005, X = 2006, Y = 2007, Z = 2008, A = 2009, B = 2010, C = 2011, etc.
Example: Serial no. ARUH-0054: the third letter is U, so the year of construction is 2004.

Intended operating area and operating conditions

Hazardous areas classified by zones

The device is intended for use in explosion-hazard areas or mines, in which firedamp classified by zone 0, zone 1 or zone 2 may occur. It is determined for use within a temperature range of $-20\text{ }^{\circ}\text{C}$ to $+50\text{ }^{\circ}\text{C}$, and for areas in which gases of explosion groups IIA, IIB or IIC and temperature class T3 or T4 (depending on the batteries and rechargeable battery) may be present. For zone 0, the temperature class is limited to T3. If used in mines, the device is only to be used in areas known to have a low risk of mechanical impact.

Hazardous areas classified by divisions

This device is intended to be used in hazardous areas or mines susceptible to firedamp classified as Class I & II, Div. 1 or Div. 2 within a temperature range of $-20\text{ }^{\circ}\text{C}$ to $+50\text{ }^{\circ}\text{C}$ and where gases or dusts of groups A, B, C, D or E, F, G and temperature class T3 or T4 (depending on battery pack and batteries) may be present.

Safety instructions

WARNING

To reduce the danger of explosion, do not mix new batteries with old batteries and do not mix batteries made by different manufacturers.

WARNING

Always disconnect the device from the power pack before carrying out any maintenance operations.

WARNING

Substitution of components may impair intrinsic safety.

CAUTION

Not tested in an oxygen-enriched atmosphere ($>21\text{ }^{\circ}\text{O}_2$).

Only the part of the device which is used to measure combustible gases was tested for performance in the scope of the CPS approval.

⚠ WARNING

High off-scale readings may indicate an explosive concentration.

⚠ WARNING (concerning the CPS approval):



Before each day's usage sensitivity must be tested on a known concentration of the gas to be detected equivalent to 25 to 50% of full scale concentration. Accuracy must be within 0 to +20% of the actual value. Accuracy may be corrected by calibration.

⚠ CAUTION

Only use power packs ABT 0000 (83 18 703) or HBT 0000 (83 18 704). See marking on power pack for approved batteries and related temperature class.

What is What

Front panel

- 1 Gas entry
- 2 Alarm LED
- 3 Buzzer
- 4  key
- 5  key
- 6 Display
- 7 Tool for replacing the sensor

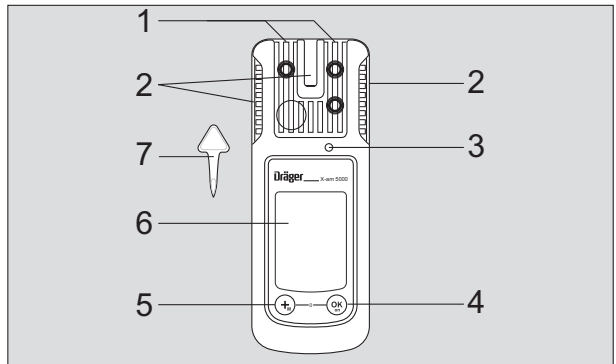

0023989_02.eps

Rear panel

- 1 IR interface
- 2 Fastening clip
- 3 Type plate
- 4 Charging contacts
- 5 Power pack
- 6 Serial no.

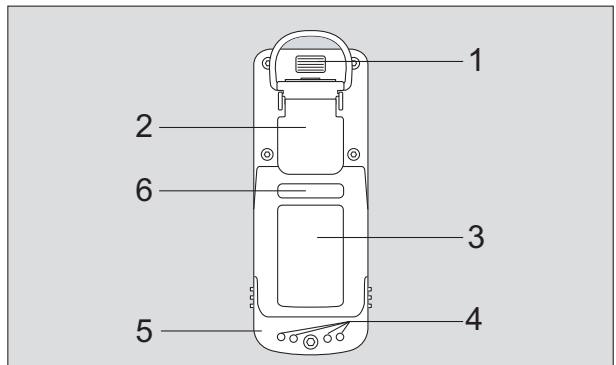

0023989_02.eps

Display

for 5 measuring channels only:

- 1 Measured gas display with unit
- 2 Measured value display
- 3 Special symbols

other:



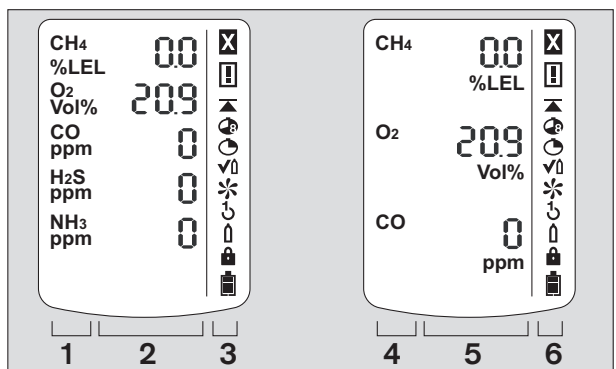











- 4 Measured gas display
- 5 Measured gas display with unit
- 6 Special symbols



00423989_02_01m.eps

The following only shows the device version with 5 measuring channels.

Special symbols

-  Fault message, refer to page 16
-  Warning message, refer to page 16
-  The peak value display for all measuring gases, refer to page 16
-  The exposure evaluation display (TWA) for measuring gases, e.g., H₂S and CO, refer to page 16
-  The exposure evaluation display (STEL) for measuring gases, e.g., H₂S and CO, refer to page 16
-  The device is set to function test with gas (bump test), refer to page 33
-  The device is set to the fresh air calibration function, refer to page 39
-  The device is set to the 1-button calibration function, refer to page 41
-  The device is set to the single gas calibration function, refer to page 43
-  The function for password entry is active, refer to page 18
-  Battery / rechargeable battery 100 % full
-  Battery / rechargeable battery 2/3 full
-  Battery / rechargeable battery 1/3 full
-  Battery / rechargeable battery empty

Configuration

Standard gas configuration

DrägerSensor	Measuring range ¹⁾	Alarm A1 ¹⁾			Alarm A2 ¹⁾		
		setpoint	can be acknowledged	self-latching	setpoint	can be acknowledged	self-latching
CatEx 125 PR [%LEL]	0 to 100	20	Yes	No	40	No	Yes
XXS O ₂ [vol. %]	0 to 25	19 ²⁾	No	Yes	23	No	Yes
XXS O ₂ 100 [vol. %]	0 to 100	18 ²⁾	No	Yes	24	No	Yes
XXS CO [ppm]	0 to 2,000	30	Yes	No	60	No	Yes
XXS CO HC [ppm]	0 to 10,000	600	Yes	No	1,200	No	Yes
XXS CO H ₂ -CP [ppm]	0 to 2,000	30	Yes	No	60	No	Yes
XXS H ₂ [ppm]	0 to 2,000	200	Yes	No	400	No	Yes
XXS H ₂ S [ppm]	0 to 200	10	Yes	No	20	No	Yes
XXS H ₂ S LC [ppm]	0 to 100	1.6	Yes	No	3.2	No	Yes
XXS H ₂ S HC [ppm]	0 to 1,000	100	Yes	No	200	No	Yes
XXS H ₂ S/CO [ppm]	0 to 200 H ₂ S 0 to 2,000 CO	10 H ₂ S 30 CO	Yes	No	20 H ₂ S 60 CO	No	Yes
XXS NO [ppm]	0 to 200	25	Yes	No	50	No	Yes
XXS NO ₂ [ppm]	0 to 50	5	Yes	No	10	No	Yes
XXS SO ₂ [ppm]	0 to 100	1	Yes	No	2	No	Yes
XXS PH ₃ [ppm]	0 to 20	0.1	Yes	No	0.2	No	Yes
XXS PH ₃ HC [ppm]	0 to 2,000	5	Yes	No	10	No	Yes
XXS HCN [ppm]	0 to 50	10	Yes	No	20	No	Yes
XXS NH ₃ [ppm]	0 to 300	50	Yes	No	100	No	Yes
XXS CO ₂ [vol. %]	0 to 5	0.5	Yes	No	1	No	Yes
XXS Cl ₂ [ppm]	0 to 20	0.5	Yes	No	1	No	Yes
XXS H ₂ HC [vol. %]	0 to 4	0.8	Yes	No	1.6	No	Yes
XXS OV [ppm]	0 to 200	10	Yes	No	20	No	Yes
XXS OV A [ppm]	0 to 200	10	Yes	No	20	No	Yes
XXS Odorant [ppm]	0 to 40	10	Yes	No	20	No	Yes
XXS Amine [ppm]	0 to 100	10	Yes	No	20	No	Yes
XXS COCl ₂ [ppm]	0 to 10	0,1	Yes	No	0,2	No	Yes
XXS O ₃ [ppm]	0 to 10	0,1	Yes	No	0,2	Yes	No
XXS NO ₂ LC [ppm]	0 to 50	0,5	Yes	No	1,0	Yes	No

- 1) Different settings can be selected to meet customer requirements on delivery. The current setting can be checked and changed with the Dräger CC Vision software. A version of Dräger CC Vision which can be used for Dräger X-am 5000 is supplied with the device on CD.
- 2) In the case of O₂ A1 is the lower alarm setpoint: an alarm is issued if the value is too low.

Standard device configuration

Function test with gas (bump test) in Quick Menu ¹⁾	Quick bump test
Fresh air calibration in Quick Menu ¹⁾	on
Life sign - optical only ¹⁾	on
Switch off ¹⁾	allowed
LEL factor ¹⁾ (CH ₄)	4.4 (4.4 vol. % corresponds to 100 %LEL)
Averaging time ¹⁾	15 minutes for STEL 8 hours for TWA

- 1) Different settings can be selected to meet customer requirements on delivery. The current setting can be checked and changed with the Dräger CC Vision software.
A version of Dräger CC Vision which can be used for Dräger X-am 5000 is supplied with the device on CD.

Changing the standard configuration: See “Configuring the Device” on page 23.

WARNING

After a basic initialization has been carried out with the PC software Dräger CC Vision, individual alarm settings may have been changed.





Activating the Device

Before using the device for the first time, insert the supplied batteries or a charged NiMH power pack T4 (order no. 83 18 704), refer to Replacing the Batteries page 47. Charge the rechargeable batteries if necessary page 48.



The Dräger X-am 5000 is ready for operation.

Operation

Switching on the device

- Press and hold the  key for approx. 3 seconds until the countdown » 3 . 2 . 1 « shown in the display has elapsed.
- All the display segments, including the visual, audible and vibration alarms, are activated for a short time.
- The software version is displayed.
- The device performs a self test.
- The next sensor which is next due for calibration is displayed with the days remaining until the next calibration, e.g., » **Ex %LEL CAL 20** «.
- The time until the bump test interval elapses is displayed in days, e.g., » **bt 123** «.
- All alarm setpoints A1 and A2 as well as »  « (TWA)¹⁾ and »  « (STEL)^{*)} for H₂S and CO are displayed in succession.
- During the warm-up period of the sensors, the respective display of the measured value flashes and the special symbol »  « (for warning) is displayed. No alarms are issued during the running-in period of the sensors.
- Press the  key to cancel the display of the activation sequence.





Switching off the device

- Press and hold the  key and  key at the same time until the countdown » 3 . 2 . 1 « shown in the display has elapsed.
- Before the device is switched off, the visual, audible and vibration alarms are activated for a short time.

Before entering the workplace

CAUTION

Check and, if necessary, adjust the calibration before carrying out safety-relevant measurements. A function test with gas (bump test) must be carried out in accordance with local regulations.

- Switch on the device. The current measured values are shown in the display.
- Observe any warning »  « or fault messages »  «.
 -  **The device can be operated normally. If the warning message does not go out automatically during operation, the device must be maintained after the end of use.**
 -  **The device is not ready to measure and requires maintenance.**

1) Only when activated in the device configuration. Delivery status: not activated.

- If one of these special symbols is displayed, appropriate measures, refer to page 25 to page 28, must be taken.
- Check that the gas inlet opening on the device is not covered.

WARNING

The presence of catalyst poisons in the measured gas (e.g., volatile silicone, sulfur, heavy metal compounds or halogenated hydrocarbons) can damage the DrägerSensor CatEx 125 PR. If the sensor cannot be calibrated to the target concentration anymore, the sensor must be replaced. The display of the CatEx 125 PR sensor may be incorrect in an oxygen-poor atmosphere. Electrical operating safety (Ex protection) is not guaranteed in an oxygen-enriched atmosphere. Danger of explosion!

During operation

During operation, the measured values for every measured gas are displayed. If a measuring range is exceeded or a negative drift occurs, the following displays are shown instead of the measured value display:

»  « (Too high concentration) or

»  « (Negative drift).

- If the concentrations of combustible materials are too high, this may be the result of a lack of oxygen.
- For O₂ concentrations below 8 vol. % a fault is indicated for the Ex channel as » - - « instead of the measurement, if the measurement is below the pre-alarm threshold (only if measuring range ≤100 % LEL, not for >100 % LEL (heat conduction)).

In the event of an alarm, the corresponding displays including the visual, audible and vibration alarms are activated – refer to “Identifying Alarms” on page 20.

When the measuring range on the CatEx channel is significantly exceeded (very high concentration of flammable substances), a latching alarm is triggered. This CatEx latching alarm is acknowledged either automatically by a functioning (i.e. free of warnings and malfunctions) oxygen channel or by manually switching the unit off and on again in fresh air.

No latching alarm is triggered when the measuring range is exceeded in the "Methane" configuration setting, as the unambiguity of the indication for methane is ensured by a separate measurement of thermal conductivity.

WARNING

After exposition to concentrations above 100 %LEL, the indication displayed at the CatEx channel may be incorrect. Before any further use of the device within the concentration range from 0 to 100 %LEL, check and, if necessary, adjust the zero point and the sensitivity.

After the measuring range of the TOX measuring channels has been exceeded temporarily (up to one hour), checking the measuring channels is not necessary.

When using a CatEx sensor in the Dräger X-am 5000, the zero point and sensitivity must be adjusted after any extreme impact loading.

Calling the Info Mode

- In measuring mode, press the  key for approx. 3 seconds.

If any warning or fault messages exist, the corresponding information or error codes are displayed (page 25 to page 31).

Press the  key successively for the next display.

The peak values and the exposition values TWA¹⁾ and STEL¹⁾ are displayed.

-  Warning messages are displayed. Numerical codes of warning messages: see page 25.

 key

-  Fault messages are displayed. Numerical codes of fault messages: see page 28.

 key

-  The peak values = the maximum measured values in the case of, e.g., CO, H₂S, ... or the minimum measured values in the case of O₂ within the storage interval are displayed

 key

-  The average values of the exposures based on a shift of, e.g., 8 hours (TWA) of all the active sensors for the exposure evaluation are displayed

 key

-  The short-term values (STEL) = average values of the concentrations over the average value duration of all the active sensors for the exposure evaluation are displayed

 key

The device is in measuring mode again

- If no key is pressed for 10 seconds, the device returns automatically to measuring mode.

Calling the Info-Off Mode

When the device is in a deactivated state, press the  key.

The name of the gas, measuring unit and measuring range limit value are displayed for all channels.

Pressing the  key again exits the Info Off mode (or via timeout).

1) Only when activated in the device configuration. Delivery status: not activated.

Calling the Quick Menu

- Only the fresh air calibration is activated in the quick menu on delivery. The PC software Dräger CC Vision can be used to activate the bump test for the quick menu and/or the function for displaying and deleting peak values.
- In measuring mode, press the \oplus key three times.
If no functions have been activated in the quick menu, the device remains in measuring mode.
- You can select the activated functions of the quick menu by pressing the \oplus key.
- Press the \odot key to call the selected function.

Possible functions of the quick menu

- $\checkmark \uparrow$ Function test with gas (bump test), refer to page 33
- \ast Fresh air calibration, refer to page 39
- \blacktriangle Displaying and deleting peak values, see below

- Press the \oplus key to cancel the active function and to switch to measuring mode.
- If no key is pressed for 60 seconds, the device returns automatically to measuring mode.

Quick menu "Displaying and deleting peak values"

After the function has been selected, the current peak values are displayed; the peak values special symbol appears in the display at the same time.

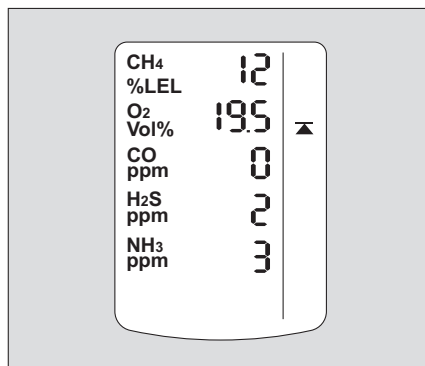

- The peak values can be deleted by pressing the **OK** key for 5 sec. The adjacent display appears.

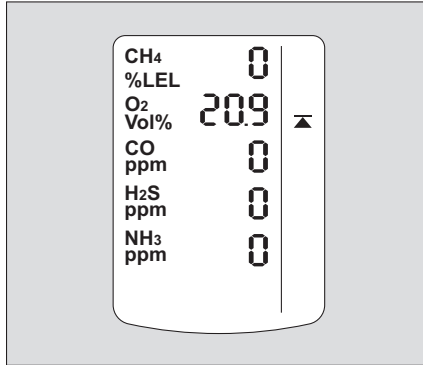

- Press the **OK** key to end the function.

Calling the Calibration Menu

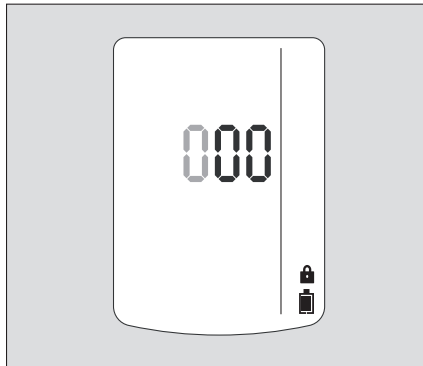

- The calibration menu can only be accessed by entering a password.
- Password on delivery: » **001** «
- The default password on delivery can be changed using the PC software Dräger CC Vision.
- In measuring mode, press the **+** key for at least 4 seconds.
- The function for entering the password is selected.
- The » **🔒** « special symbol (for the "enter password" function) is displayed.

- The display shows » **000** «, with the first digit flashing.
- Use the **+** key to set the flashing digit.
- Press the **OK** key, the second digit starts flashing.
- Use the **+** key to set the flashing digit.
- Press the **OK** key, the third digit starts flashing.
- Use the **+** key to set the flashing digit.
- Press the **OK** key to confirm the password once it has been set completely.



- The calibration menu functions can now be selected by pressing the **+** key.
- Press the **OK** key to call the selected function.

Calibration menu functions

-  Fresh air calibration, refer to page 39
-  1-button calibration, refer to page 41
-  Single gas calibration, refer to page 43

- Press the ⊕ key to cancel the active function.
- If no key is pressed for 10 minutes, the device automatically returns to measuring mode.

Identifying Alarms

An alarm is displayed visually, audibly and through vibration in a specific pattern.

Concentration pre-alarm A1

The alarm is indicated by an intermittent alarm message:



Display » **A1** « and measured value alternating: not for O₂!

- The pre-alarm A1 is not self-latching and stops when the concentration has dropped below the alarm setpoint A1.
- In the case of A1 a single tone is audible and the alarm LED flashes.

Acknowledging the pre-alarm:

- Press the  key. Only the audible alarm and the vibration alarm are switched off.

Concentration main alarm A2

The alarm is indicated by an intermittent alarm message:



Display » **A2** « and measured value alternating:



In the case of A2 a double tone is audible and the alarm LED flashes twice.

For O₂: » **A1** « and measured value alternating = oxygen deficiency
» **A2** « and measured value alternating = oxygen surplus

DANGER



Leave the area immediately. Danger to life! A main alarm is self-latching and cannot be acknowledged or cancelled.

After leaving the area, if the concentration is less than the alarm setpoint A2:

- Press the  key. The alarm messages are switched off.
- A latching alarm on the CatEx channel (due to the measuring range being significantly exceeded) cannot be acknowledged by the  key. The CatEx latching alarm is acknowledged either automatically by a functioning (i.e. free of warnings and malfunctions) oxygen channel or by manually switching the unit off and on again in fresh air.

STEL / TWA exposure alarm

The alarm is indicated by an intermittent alarm message: 

Display » **A2** « and »  « (TWA) or »  « (STEL) and measured value alternating:

 CAUTION
Leave the area immediately. After this alarm, the deployment of personnel is subject to the relevant national regulations.

- STEL and TWA alarms cannot be acknowledged or canceled.
- Switch off the device. The values for the exposure evaluation are deleted after the device is switched on again.

Battery pre-alarm

The alarm is indicated by an intermittent alarm message: 

Flashing special symbol »  « on the right side of the display:

Acknowledging the pre-alarm:

- Press the  key. Only the audible alarm and the vibration alarm are switched off.
- The battery still lasts approx. 20 minutes after the first battery pre-alarm.

Battery main alarm

The alarm is indicated by an intermittent alarm message: 

Flashing special symbol »  « on the right side of the display:

The battery main alarm cannot be acknowledged or canceled:

- The device is automatically switched off again after 10 seconds.
- Before the device is switched off, the visual, audible and vibration alarms are activated for a short time.

Device alarm

The alarm is indicated by an intermittent alarm message: 

Special symbol »  « on the right side of the display:

- The device or one or several sensor channels are not ready for operation.
- For remedies, refer to page 25 to page 31.
- If necessary, commission the Dräger Service Center to eliminate the error.

Operation with pump

With Dräger Pump X-am 1/2/5000

Accessories:

Dräger Pump X-am 1/2/5000, sampling hose and probes, refer to Order List, see “Accessories” on page 60..

Commissioning and performing the measurement:

- Refer to the Instructions for Use of the Dräger Pump X-am 1/2/5000.

With manual pump adapter and rubber ball pump

Accessories:

For manual pump adapter, rubber ball pump, sampling hose and probes, refer to Order List, see “Accessories” on page 60..

Commissioning and performing the measurement:

- Refer to the Instructions for Use of the accessories used.

Observe the following during measuring mode with pump

- The required waiting time when flushing the hose probe:
 - Before every measurement, flush the Dräger sampling hose or the Dräger probes with the air sample to be measured.
 - It is absolutely necessary to flush the extension hose to eliminate or minimize the effects which may interfere with measurements when using a sampling hose or a probe, e.g., memory effects, dead volume.
 - The flushing phase depends on various factors, e.g., type and concentration of the gas or vapor to be measured, material, length, diameter, and age of the sampling hose or probe. Generally, when using a sampling hose (new, dry, clean), a typical flushing time of approx. 3 seconds is required for each meter. This flushing time applies in addition to the sensor response time (see the Instructions for Use of the gas measuring device used).
- Example:
 - In the case of a sampling hose with a length of 10 m, the flushing time is approx. 30 seconds and the sensor response time is in addition approx. 60 seconds. Therefore, the total time before reading the gas measuring device is approx. 90 seconds.
 - The flow rate alarm is delayed by 10 to 30 seconds depending on the length of the hose.

Configuring the Device

To individually configure a device with standard configuration, the device must be connected with a PC.

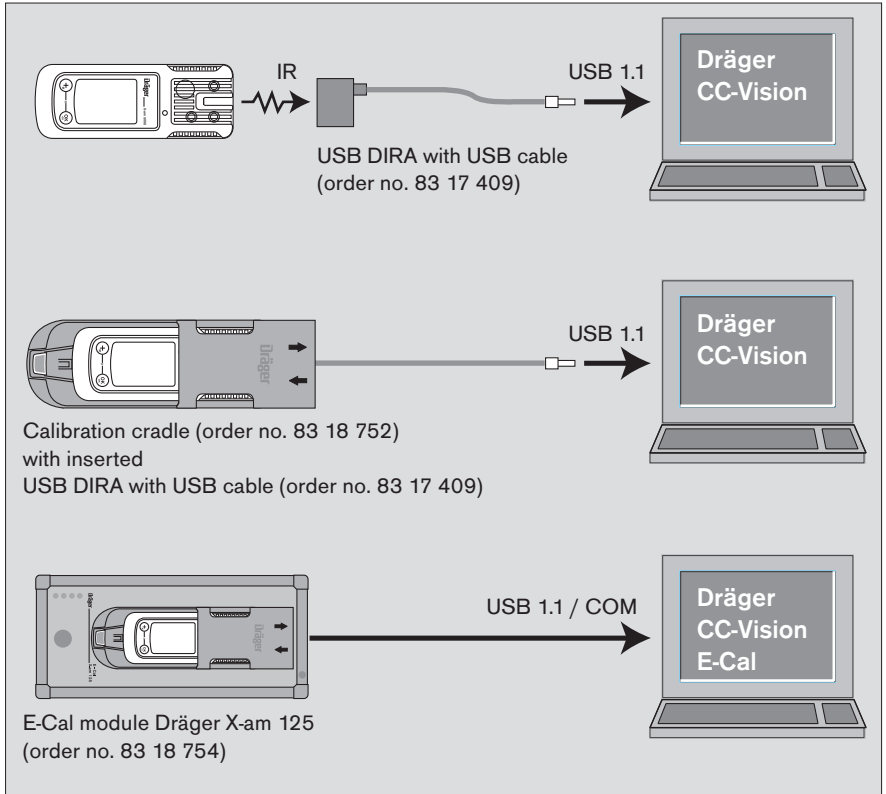

The installed PC software Dräger CC Vision is used for configuration.

- Observe the documentation and online help of the software.
- A Dräger CC Vision version which can be used for Dräger X-am 5000 is supplied with the device on CD.

Read Database and Display Graphically

To read the database of the device and display it graphically, the device must be connected with a PC.

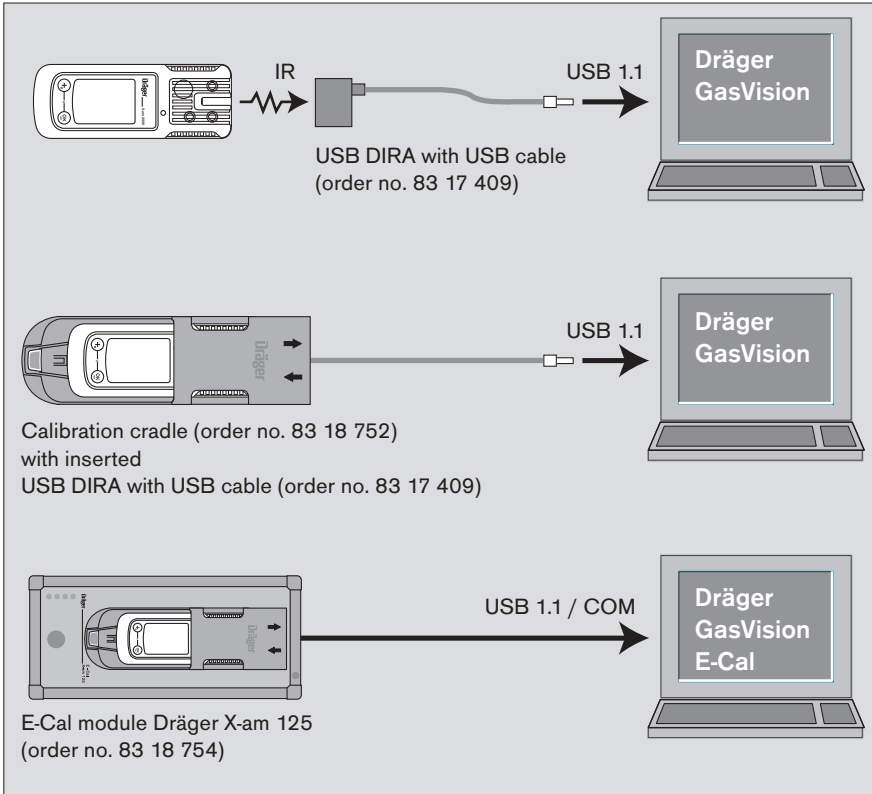

The installed PC software Dräger GasVision is used for reading and displaying the database.

- Observe the documentation and online help of the software.

Faults, Cause and Remedy

Fault	Cause	Remedy
Not possible to switch on the device	Discharge the power pack	Charge the power pack, page 48.
	Discharge the alkaline batteries	Insert new alkaline batteries, page 47.
Not possible to switch off the device	The device is not set to measuring mode	Select measuring mode.
	The device is configured to "Disable prohibited"	Configure the device to "Disable allowed" with Dräger CC Vision.
Display » -- «	Measuring range calibrated incorrectly	Recalibrate the measuring range, page 38.
	Electronics or sensors defective	Must be repaired by DrägerService.

To display the numerical codes of the warning and fault messages in the info mode, page 16.

Warning messages

Special symbol » ⓘ « and displayed numerical code:	Cause	Remedy
152	Customer's service life counter about to elapse	Reset the service life counter using Dräger CC Vision.
153	Database 90 % full	Read the database soon and clear memory afterwards.
154	Database full	Read the database and clear memory.
155	Interval for the function test with gas (bump test) elapsed	Carry out the function test, page 33.
159	Calibration not possible. The menu function cannot be carried out because of a message which is preventing the function (e.g., sensors in warm-up phase).	Determine the message code via the info menu and switch it off, if necessary.
251	DrägerSensor CatEx 125 PR in warm-up phase	Wait until warm-up time is complete.
252	DrägerSensor CatEx 125 PR in warm-up phase	Wait until warm-up time is complete.

Special symbol » ⓘ « and displayed numerical code:	Cause	Remedy
253	Ex concentration has drifted into the negative range	Carry out fresh air calibration, page 39.
254	The temperature is too high	Operate the device within the allowed temperature range.
255	The temperature is too low	Operate the device within the allowed temperature range.
256	The calibration interval for DrägerSensor CatEx 125 PR has elapsed	Carry out sensitivity calibration for DrägerSensor CatEx 125 PR, page 43.
257	Alarm setpoint A2 setting is greater than 60 %LEL	Set alarm setpoint to less than 60 % LEL.
271	The calibration interval for thermal conduction for DrägerSensor CatEx 125 PR has elapsed	Carry out sensitivity calibration for DrägerSensor CatEx 125 PR, page 43.

351	DrägerSensor XXS EC1 in the warm-up phase	Wait until warm-up time is complete.
352	DrägerSensor XXS EC1 in the warm-up phase	Wait until warm-up time is complete.
353	EC1 concentration has drifted into the negative range	Carry out fresh air calibration, page 39.
354	The temperature is too high	Operate the device within the allowed temperature range.
355	The temperature is too low	Operate the device within the allowed temperature range.
356	The calibration interval for DrägerSensor XXS EC1 has elapsed	Carry out sensitivity calibration for DrägerSensor XXS EC1, page 43.
357	Alarm setpoint A2 setting is greater than 60 %LEL	Set alarm setpoint to less than 60 %LEL.

451	DrägerSensor XXS EC2 in the warm-up phase	Wait until warm-up time is complete.
452	DrägerSensor XXS EC2 in the warm-up phase	Wait until warm-up time is complete.
453	EC2 concentration has drifted into the negative range	Carry out fresh air calibration, page 39.
454	The temperature is too high	Operate the device within the allowed temperature range.
455	The temperature is too low	Operate the device within the allowed temperature range.

Special symbol » ⓘ « and displayed numerical code:	Cause	Remedy
456	The calibration interval for DrägerSensor XXS EC2 has elapsed	Carry out sensitivity calibration for DrägerSensor XXS EC 3, page 43.
457	Alarm setpoint A2 setting is greater than 60 %LEL	Set alarm setpoint to less than 60 %LEL.
551	DrägerSensor XXS EC3 in the warm-up phase	Wait until warm-up time is complete.
552	DrägerSensor XXS EC3 in the warm-up phase	Wait until warm-up time is complete.
553	EC3 concentration has drifted into the negative range	Carry out fresh air calibration, page 39.
554	The temperature is too high	Operate the device within the allowed temperature range.
555	The temperature is too low	Operate the device within the allowed temperature range.
556	The calibration interval for DrägerSensor XXS EC3 has elapsed	Carry out sensitivity calibration for DrägerSensor XXS EC 3, page 43.
557	Alarm setpoint A2 setting is greater than 60 %LEL	Set alarm setpoint to less than 60 %LEL.
575	The calibration interval for the compensation electrode has elapsed	Carry out sensitivity calibration for compensation electrode.
576	Calibration required because of overgassing.	Perform a span calibration for the compensation electrode.
651	DrägerSensor XXS EC 4 in the warm-up phase	Wait until warm-up time is complete.
652	DrägerSensor XXS EC 4 in the warm-up phase	Wait until warm-up time is complete.
653	EC 4 concentration has drifted into the negative range	Carry out fresh air calibration, page 39.
654	The temperature is too high	Operate the device within the allowed temperature range.
655	The temperature is too low	Operate the device within the allowed temperature range.
656	The calibration interval for DrägerSensor XXS EC 4 has elapsed	Carry out sensitivity calibration for DrägerSensor XXS EC 4, page 43.
657	Alarm setpoint A2 setting is greater than 60 %LEL	Set alarm setpoint to less than 60 %LEL.

Fault messages

Special symbol » ☒ « and displayed numerical code:	Cause	Remedy
102	The customer's service life counter has elapsed	Reset the service life counter using Dräger CC Vision.
103	The device is defective	The device must be repaired by DrägerService.
104	Check sum error program code	The device must be repaired by DrägerService.
105	The bump test interval has elapsed	Carry out bump test, page 36.
106	The calibration interval has elapsed (at least 1 calibration interval has elapsed)	Carry out sensitivity calibration, page 41 or page 43.
107	Bump test error (at least 1 channel has a bump test error)	Carry out bump test, page 36 or carry out sensitivity calibration, page 41 or page 43.
108	The device is defective	The device must be repaired by DrägerService.
109	The menu function cannot be carried out because of an error.	Determine the error code via the info menu and switch it off, if necessary.
111	Failed alarm element test: alarm light.	Repeat alarm element test with Dräger X-dock.
112	Failed alarm element test: alarm horn.	Repeat alarm element test with X-dock.
113	Failed alarm element test: Vibration motor.	Repeat alarm element test with X-dock.
114	Failed visual inspection.	Repeat visual inspection with X-dock.
115	Device is disabled by X-dock.	Activate device with X-dock.
116	Failed software update.	The device must be repaired by DrägerService.
201	The zero point calibration of DrägerSensor CatEx 125 PR is not valid	Carry out fresh air calibration, page 39.
202	The sensitivity calibration of DrägerSensor CatEx 125 PR is not valid	Carry out sensitivity calibration, page 41 or page 43.

Special symbol » ☒ « and displayed numerical code:	Cause	Remedy
203	The measurement value of DrägerSensor CatEx 125 PR is in the negative range	Carry out fresh air calibration, page 39.
204	DrägerSensor CatEx 125 PR is not inserted or defective	Check DrägerSensor CatEx 125 PR, page 51.
205	Error during the function test with gas (bump test) of DrägerSensor CatEx 125 PR	Repeat the function test. Calibrate or replace DrägerSensor CatEx 125 PR, if necessary page 51.
207	Failed rise time test.	Repeat rise time test with X-dock.
221	DrägerSensor CatEx 125 PR cannot be operated due to oxygen deficiency	Use in the sensor in an environment containing at least 10 vol. % O ₂ .
222	No valid zero point calibration of DrägerSensor CatEx 125 PR for thermal conduction	Carry out fresh air calibration, page 39.
223	No valid sensitivity calibration of DrägerSensor CatEx 125 PR for thermal conduction	Carry out sensitivity calibration for thermal conduction, page 41 or page 43.

301	The zero point calibration of DrägerSensor XXS EC1 is not valid	Carry out fresh air calibration, page 39.
302	The sensitivity calibration of DrägerSensor XXS EC1 is not valid	Carry out sensitivity calibration. Carry out page 43 or fresh air calibration, page 39.
303	The measured value of DrägerSensor XXS EC 1 is in the negative range	Carry out fresh air calibration, page 39.
304	DrägerSensor XXS EC1 is not inserted or defective	Check DrägerSensor XXS EC1, page 51.
305	Error during the function test with gas (bump test) of DrägerSensor XXS EC1	Repeat function test. Calibrate or replace DrägerSensor XXS EC1, if necessary page 51.
306	Failed filter test.	Repeat filter test with X-dock.
307	Failed rise time test.	Repeat rise time test with X-dock.
326	Error during warm-up acceleration Dräger Sensor XXS EC1	Disconnect and reconnect power pack or replace the sensor. Sensor must not be loaded with gas within the first 5 minutes.

Special symbol » ☒ « and displayed numerical code:	Cause	Remedy
--	-------	--------

401	The zero point calibration of DrägerSensor XXS EC2 is not valid	Carry out fresh air calibration, page 39.
402	The sensitivity calibration of DrägerSensor XXS EC2 is not valid	Carry out sensitivity calibration, page 43.
403	The measured value of DrägerSensor XXS EC 2 is in the negative range	Carry out fresh air calibration, page 39.
404	DrägerSensor XXS EC2 is not inserted or defective	Check DrägerSensor XXS EC2, page 51.
405	Error during the function test with gas (bump test) of DrägerSensor XXS EC2	Repeat function test. Calibrate or replace DrägerSensor XXS EC2, if necessary page 51.
406	Failed filter test.	Repeat filter test with X-dock.
407	Failed rise time test.	Repeat rise time test with X-dock.
426	Error during warm-up acceleration Dräger Sensor XXS EC2	Disconnect and reconnect power pack or replace the sensor. Sensor must not be loaded with gas within the first 5 minutes.

501	The zero point calibration of DrägerSensor XXS EC3 is not valid	Carry out fresh air calibration, page 39.
502	The sensitivity calibration of DrägerSensor XXS EC3 is not valid	Carry out sensitivity calibration, page 43.
503	The measured value of DrägerSensor XXS EC3 is in the negative range	Carry out fresh air calibration, page 39.
504	DrägerSensor XXS EC3 is not inserted or defective	Check DrägerSensor XXS EC3, page 51.
505	Error during the function test with gas (bump test) of DrägerSensor XXS EC3	Repeat function test. Calibrate or replace DrägerSensor XXS EC3, if necessary page 51.
506	Failed filter test.	Repeat filter test with X-dock.
507	Failed rise time test.	Repeat rise time test with X-dock.

Special symbol » X « and displayed numerical code:	Cause	Remedy
525	The sensitivity calibration for the compensation channel is not valid	Carry out sensitivity calibration for compensation electrode.
526	Error during warm-up acceleration Dräger Sensor XXS EC3	Disconnect and reconnect power pack or replace the sensor. Sensor must not be loaded with gas within the first 5 minutes.

601	The zero point calibration of DrägerSensor XXS EC4 is not valid	Carry out fresh air calibration, page 39.
602	The sensitivity calibration of DrägerSensor XXS EC4 is not valid	Carry out sensitivity calibration, page 43.
603	The measured value of DrägerSensor XXS EC4 is in the negative range	Carry out fresh air calibration, page 39.
604	DrägerSensor XXS EC4 is not inserted or defective	Check DrägerSensor XXS EC4, page 51.
605	Error during the function test with gas (bump test) of DrägerSensor XXS EC4	Repeat function test. Calibrate or replace DrägerSensor XXS EC 4, if necessary page 51.
606	Failed filter test.	Repeat filter test with X-dock.
607	Failed rise time test.	Repeat rise time test with X-dock.
626	Error during warm-up acceleration Dräger Sensor XXS EC4	Disconnect and reconnect power pack or replace the sensor. Sensor must not be loaded with gas within the first 5 minutes.

Maintenance

Maintenance intervals

The device should be inspected and maintained by suitably qualified persons annually (consult: EN 60079-29-2 – Gas measuring device - Selection, installation, use and maintenance of apparatus for the measurement of combustible gases or oxygen, EN 45544-4 – Electrical apparatus used for the direct detection and direct concentration measurement of toxic gases and vapors - Part 4: Guide for selection, installation, use and maintenance and national regulations).

Recommended calibration interval for the measuring channels Ex, O₂, H₂S and CO: 6 months.

Calibration interval of other gases: refer to the Instructions for Use of the respective DrägerSensors.

- Depending on device configuration:
 - Replace the alkaline batteries or charge the battery – refer to page 47 to page 48 – after each use, at the latest after the battery alarm has been triggered or after 2 weeks.
- Calibrating the device – page 38.
 - In regular intervals, according to the sensors used and the operating conditions. For sensor-specific calibration data, refer to the Instructions for Use/data sheets of the sensors used¹⁾.
 - Before you carry out safety-related relevant measurements, the zero point and sensitivity of the devices should be tested in accordance with national regulations.
- Inspection by suitably qualified persons – every year.
 - The inspection intervals must be established in each individual case and shortened if necessary, depending on technical safety considerations, engineering conditions and the technical requirements of the equipment.
 - We recommend that a service agreement be concluded with Dräger and that repairs also be carried out by them.
- Replace the sensors, page 51 – if necessary, when it is not possible to calibrate the sensors anymore.

1) The Instructions for Use/data sheets of the sensors used are supplied with the device on CD. See also attached Instructions for Use and Data Sheets of the sensors used. The Instructions for Use/data sheets of the sensors used can also be downloaded from the following Internet address: www.draeger.com

Carrying Out the Function Test with Gas (Bump Test)

Manual implementation without the documentation of results in the device memory

- Prepare a test gas cylinder, the volume flow must be 0.5 L/min and the gas concentration must be higher than the alarm setpoint concentration to be tested.
Example test gas cylinder 68 11 130 = mixed gas with 50 ppm CO, 15 ppm H₂S, 2.5 vol. % CH₄, 18 vol. % O₂
- Connect the test gas cylinder with the calibration cradle (83 18 752).
- Vent the test gas into a fume cupboard or into the open air (with a hose connected to the second connector of the calibration cradle).

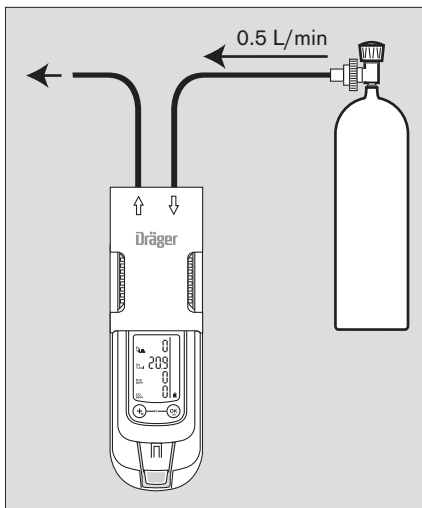

CAUTION

Do not inhale the test gas. Risk to health! Observe the hazard warnings of the relevant Safety Data Sheets.

- Switch on the device and insert it into the calibration cradle – press downwards until it engages.
- Open the test gas cylinder valve to let test gas flow over the sensors.
- Recommendation: Wait until the device displays the test gas concentration with sufficient tolerance –
Ex: $\pm 20\%$ ¹⁾
O₂: ± 0.6 vol. % ¹⁾
TOX: $\pm 20\%$ ¹⁾
Wait at least until the alarm setpoint A1 or A2 is exceeded.
- If the alarm setpoints are exceeded, the device displays the gas concentration in alternation with » **A1** « or » **A2** « depending on the test gas concentration.
- Close the test gas cylinder valve and remove the device from the calibration cradle

1) Upon application of the Dräger mixed gas (order no. 68 11 130) the displays should be within this range.

- If the concentration has now fallen under the A1 alarm setpoint:
 - Acknowledge the alarm.
 - If the displays are outside of the above-mentioned ranges:
 - Calibrating the device, refer to page 38.

Menu implementation with the documentation of results in the device memory

The "Quick bump test" or the "Extended bump test" is selected using the Dräger CC Vision PC software. The "Quick bump test" checks whether the gas concentration has exceeded the Alarm 1 threshold (with oxygen, the check is whether the concentration has fallen below the Alarm 1 threshold). The "Extended bump test" checks whether the gas concentration has exceeded the Alarm 1 threshold (with oxygen, the check is whether the concentration has fallen below the Alarm 1 threshold) and whether the gas concentration has reached the preset bump test concentration.

Setting on delivery: Quick bump test.

- Prepare a test gas cylinder, the volume flow must be 0.5 L/min and the gas concentration must be higher than the alarm setpoint concentration to be tested.
Example test gas cylinder 68 11 130 = mixed gas with 50 ppm CO, 15 ppm H₂S, 2.5 vol. % CH₄, 18 vol. % O₂
- Connect the test gas cylinder with the calibration cradle (83 18 752).
- Vent the test gas into a fume cupboard or into the open air (with a hose connected to the second connector of the calibration cradle).

⚠ CAUTION

Do not inhale the test gas. Risk to health!
Observe the hazard warnings of the relevant Safety Data Sheets.

- Switch on the device and insert it into the calibration cradle – press downwards until it engages.
- Call the quick menu and select the function test with gas (bump test), page 17.

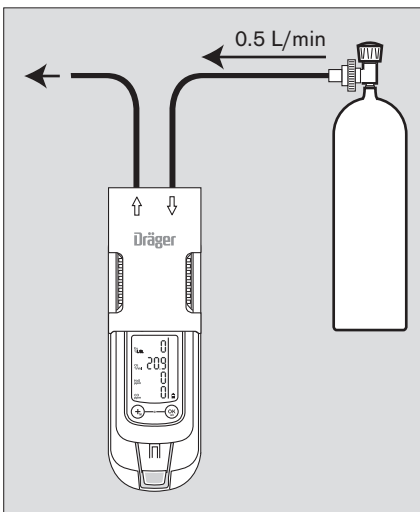

00523999_01_enxeps

- The current gas concentration values and the special symbol » √↑ « (for bump test) flash.
- Press the (OK) key to start the function test with gas.
- Open the test gas cylinder valve to let test gas flow over the sensor.
- If gas concentration exceeds the alarm thresholds A 1 or A 2 the corresponding alarm will occur. Exit the function test with gas:

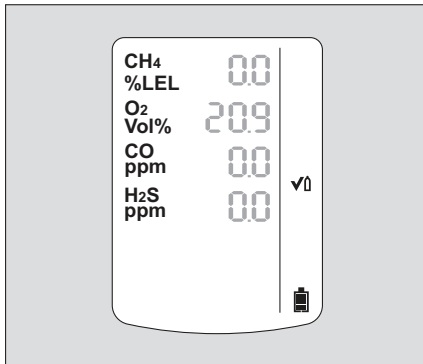

02423989_01_en.eps

After the preset bump test concentration is reached or a gas alarm is triggered (with the "Quick bump test"):

- The display containing the current gas concentration changes with the display » OK «.
- The bump test that was carried out is documented with the result and date in the device memory.
- Close the test gas cylinder valve and remove the device from the calibration cradle.
- If the concentration values have now fallen under the A1 alarm setpoints, the device returns to the measuring mode.

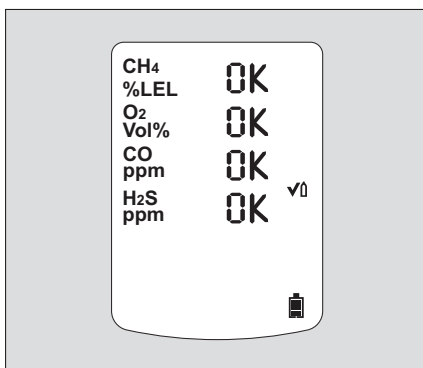

02423989_01_en.eps

- If the set bump test concentration is not reached within the specified time, the alarm mode is activated to indicate failure.
- The fault message » ✖ « appears and » - - « is displayed instead of the measured value on the faulty measuring channel.
- In this case, repeat the function test with gas or calibrate the device, page 38.

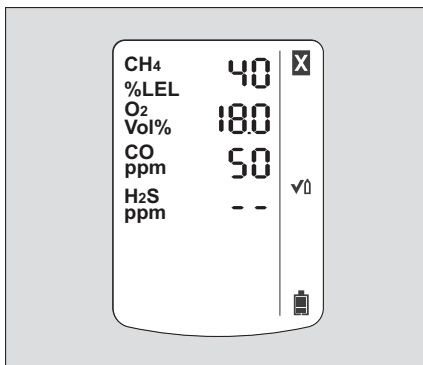

02423989_01_en.eps

The function test with gas can also be carried out automatically. The "Bump Test Station" is required for this function, refer to page 36.

Automatic implementation with the Bump Test Station

Prerequisite:

The device must first be configured for the automatic function test with gas (bump test) using the PC software Dräger CC Vision.

- Activating the device for the automatic function test.
- Composition of test gas (mixed gas) – standard on delivery: 50 ppm CO, 15 ppm H₂S, 2.5 vol. % CH₄, 18 vol. % O₂
- Define which measuring channels should participate in the automatic function test. All measuring channels participate in the function test by default.

- Prepare the Bump Test Station according to the instructions.
- Switch on the device and insert it into the receptacle of the Bump Test Station until it engages.

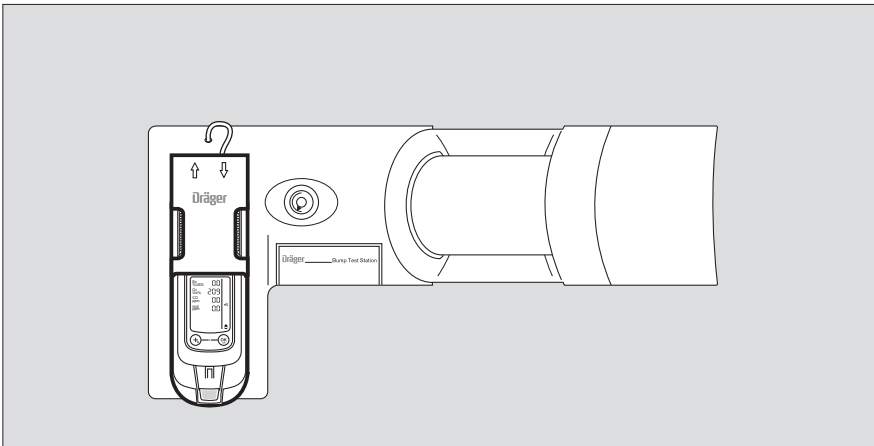

03823589_01.eps

- The function test with gas is started automatically. The special symbol » √ ◀ (for bump test) flashes.
- If a gas alarm (Quick bump test) is triggered and the preset bump test concentration (Extended bump test) is reached within the specified time, the display shows the current gas concentration, alternating with » OK ◀.

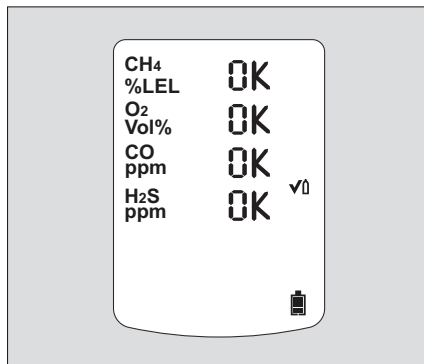

02529899_01_en.eps

- Remove the device from the Bump Test Station.
- If the concentration values have now fallen under the A1 alarm setpoints, the device returns to the measuring mode.

- An error will be triggered if the preset bump test concentration is not reached within the specified time.
- The fault message »  « appears and » - - « is displayed instead of the measured value on the faulty measuring channel.
- In this case, repeat the function test with gas or calibrate the device, page 38.

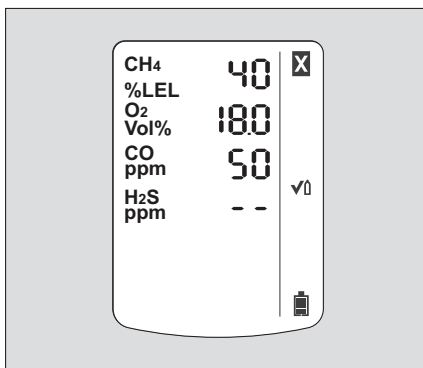

02823898_01_enxps

The function test with gas can also be carried out manually, refer to page 33 and page 34.

The PC program Dräger CC Vision can be used to enable the "Automatic calibration after incorrect bump test" option.

Calibrating the Device

Calibration may not be possible due to device and channel errors.

Allow the sensors to warm up before the calibration!

Warm-up time: refer to the Instructions for Use/data sheets of the DrägerSensors installed (on CD).

Calibration interval:

- Observe the relevant specifications in the Instructions for Use/data sheets of the DrägerSensors installed.
- For critical applications, observe the recommendations in EN 60079-29-2¹⁾ or EN 45544-4²⁾ and national regulations. We recommend that you calibrate the channels after 6 months.

▲ CAUTION
Do not inhale the test gas. Risk to health! Observe the hazard warnings of the relevant Safety Data Sheets.

- Improve the zero point accuracy – carry out the fresh air calibration, page 39.
- Set the sensitivity of all sensors to the value of the test gas – carry out the 1-button calibration, page 41.
- Set the sensitivity of a sensor to the value of the test gas – calibrate the sensitivity, page 43.

1) EN 60079-29-2 – Gas measuring device - Selection, installation, use and maintenance of apparatus for the measurement of combustible gases or oxygen

2) EN 45544-4 – Electrical devices for the direct detection and direct concentration measurement of toxic gases and vapors – Part 4: Guidelines for selection, installation, use and maintenance.

Carrying out the fresh air calibration

To improve the zero point accuracy, you can carry out a fresh air calibration.

If none of the sensors fitted permits calibration with fresh air (e.g. only O₃, only IR-CO₂), fresh air calibration is not offered as a menu function.

- Calibrate the device to fresh air, free of measured gases or other interfering gases.
- Not all sensors are included in the fresh air calibration¹⁾. Sensors which have not warmed up or which are faulty prevent a calibration.

In the case of sensors which are in the warm-up phase, the message » **159** « is displayed with the special symbol »  « (for warning message).

In the case of a sensor or device error, the message » 109 « is displayed with the special symbol »  « (for a fault message).

The message is cleared after 5 seconds and the function is available again in the menu

- During the fresh air calibration, the zero point of all sensors (with the exception of DrägerSensor XXS O₂) is set to 0.
In the case of DrägerSensor XXS O₂, the display is set to 20.9 vol. %.
- Switch on the device.

Depending on device configuration:

- Call the quick menu and select the Fresh Air Calibration function, page 17.
or
- Call the calibration menu and select the Fresh Air Calibration function, page 18.
- The current gas concentration values flash.
When the measured values have stabilized:
- Press the  key to perform the fresh air calibration.

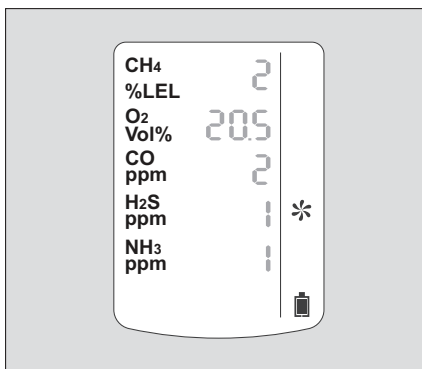

03123989_01_en.indd

1) Fresh air calibration / zero point adjustment is not supported by the DrägerSensor XXS O₃. A zero point calibration / adjustment of these sensors can be conducted using the Dräger CC-Vision PC software. To do so, a suitable zero gas that is free of ozone (e.g. N₂) should be used.

- The display containing the current gas concentration changes with the display » **OK** «.
- Press the  key to confirm the calibration or wait for approx. 5 seconds.

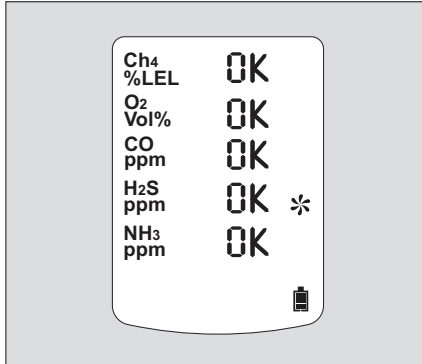

03323999_01_en_aps

If a fault occurred during the fresh air calibration.

- The fault message »  « appears and » - - « is displayed for the respective sensor instead of the measured value.
- In this case, repeat the fresh air calibration.
- If necessary, replace the sensor, page 51.

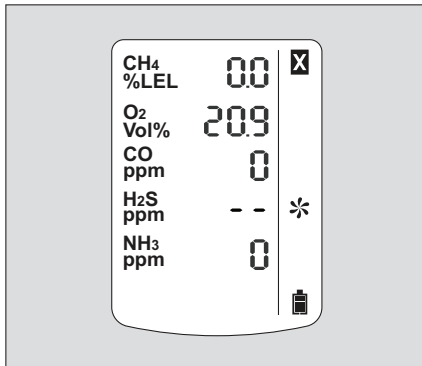

03323999_01_en_aps

Carrying out 1-button calibration

- If no sensors are enabled for 1-button calibration by the Dräger CC Vision PC program, the 1-button calibration menu function will not be offered.
- All sensors that are enabled by the Dräger CC Vision PC program take part in the 1-button calibration.
- In the case of the 1-button calibration, the sensitivity of all sensors is set to the value of the test gas.

When using the test gas cylinder 68 11 130 = mixed gas with 50 ppm CO, 15 ppm H₂S, 2.5 vol. % CH₄, 18 vol. % O₂.

- **If a mixed gas with another composition is used, the specified concentration values in the device must be changed to the target values of the mixed gas used using the PC software Dräger CC Vision.**
- Connect the test gas cylinder with the calibration cradle.
- Vent the test gas into a fume cupboard or into the open air (with a hose connected to the second connector of the calibration cradle).

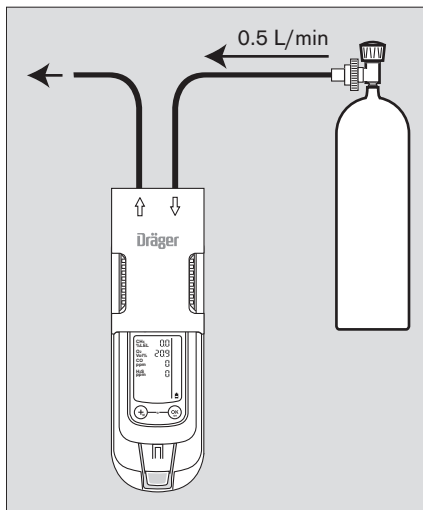

02723999_01_en.eps

CAUTION

Do not inhale the test gas. Risk to health!
Observe the hazard warnings of the relevant Safety Data Sheets.

- Switch on the device and insert it into the calibration cradle until it engages.
- Call the calibration menu, enter the password and select the 1-button calibration function, page 18.
- Press the **OK** key to start the 1-button calibration.

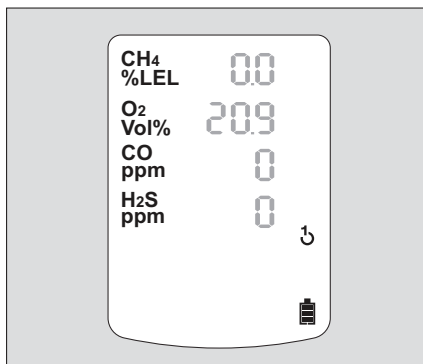

02823999_01_en.eps

- Open the test gas cylinder valve to let test gas flow over the sensor.
- The currently displayed measured values start to flash.
- The flashing stops after a static measured value has been reached.
- The calibration is now carried out automatically.
- The displayed measured values change to the values according to the gas supplied.
- The automatic stability monitoring can be overridden by pressing the OK key. A calibration then takes place immediately. If it is detected that no test gas has been applied, the 1-button calibration will be aborted. The channels will then indicate » n/a «. If only one sensor is taking part in the 1-button calibration, a calibration will be performed in each case when the OK key is pressed.

When the calibration is completed and the displayed measured values have stabilized:

- The display containing the current gas concentration changes with the display » **OK** «.
- Press the **OK** key or wait for 5 seconds to quit the calibration.
- The device changes to the measuring mode
- Close the test gas cylinder valve and remove the device from the calibration cradle.

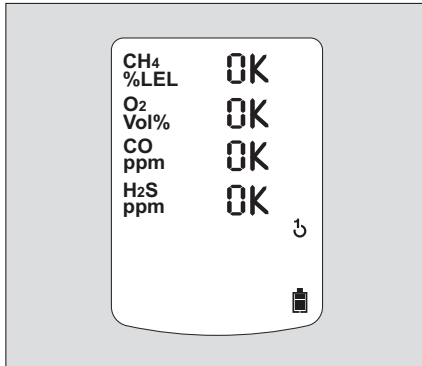

02929990_01_en.eeps

If a fault occurred during the 1-button calibration.

- The fault message » **✖** « appears and » - - « is displayed for the respective sensor instead of the measured value.
- In this case, repeat the 1-button calibration or carry out a single gas calibration, refer to page 43.
- If necessary, replace the sensor, page 51.

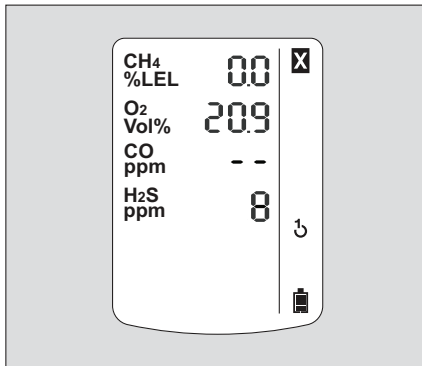

03029990_01_en.eeps

Calibrating the sensitivity for an individual measuring channel

- The sensitivity calibration can be carried out specifically for individual sensors.
- In the case of the sensitivity calibration, the sensitivity of the selected sensor is set to the value of the test gas used.
- Use a standard test gas.

Allowed test gas concentration:

Ex: 40 to 100 %LEL

O₂ 10 to 25 vol. %

CO: 20 to 999 ppm

H₂S: 5 to 99 ppm

Test gas concentration of other gases: refer to the Instructions for Use of the respective DrägerSensors.

- Connect the test gas cylinder with the calibration cradle.
- Vent the test gas into a fume cupboard or into the open air (with a hose connected to the second connector of the calibration cradle).

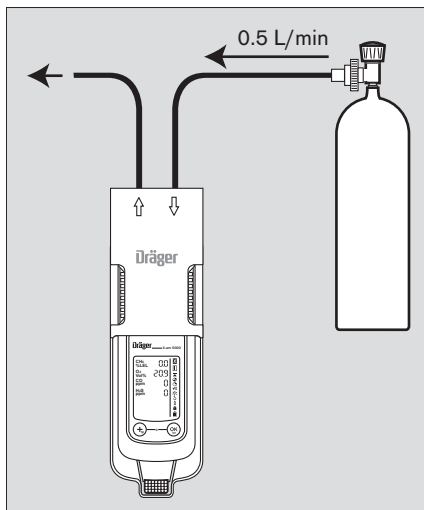

02723989_01_en.eps

⚠ CAUTION

Do not inhale the test gas. Risk to health!
Observe the hazard warnings of the relevant Safety Data Sheets.

- Switch on the device and insert it into the calibration cradle.
- Press and hold the [+] key for 5 seconds to call the calibration menu, enter the password and select the single gas calibration function, page 18.
- Press the \odot key to start the channel selection.
 - The display flashes the gas of the first measuring channel, e.g., » Ex - %LEL «.
- Press the \odot key to carry out the calibration of this measuring channel, or
- Use the \oplus key to select another measuring channel (O₂ - vol. %, H₂S - ppm or CO - ppm).

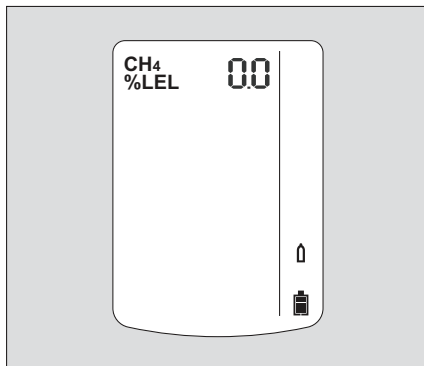

03523989_01_en.eps

Sensitivity calibration for CatEx

- When the measuring range limit is ≤ 100 LEL, only the calibration for catalytic effect is offered. Display in the case of channel selection:
- Press the **OK** key to start the calibration for catalytic effect.



05123999_01_en.pdf

- Press the **+** key to select the next sensor.

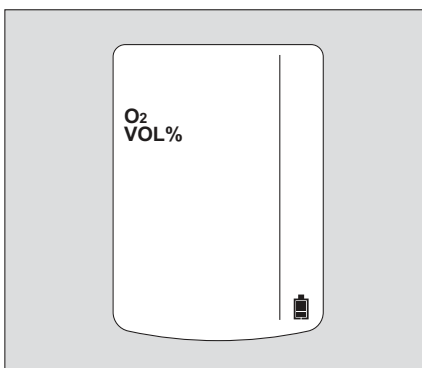

05223999_01_en.pdf

- When the measuring range limit is >100 LEL, the calibration for catalytic effect and thermal conduction is offered, display in the case of channel selection:



05123999_01_en.pdf

- After the **OK** key has been pressed the following display appears in the display:

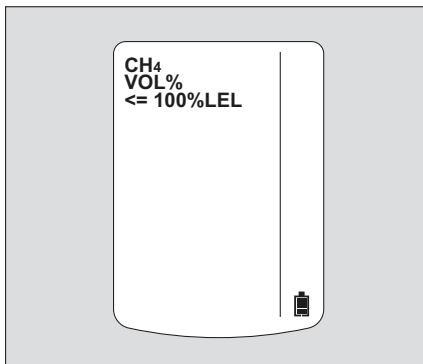

0523996_01_en.eps

- Press the **OK** key to start the calibration for catalytic effect.
- After the **+** key has been pressed the following display appears in the display:



05423966_01_en.eps

- Press the **OK** key to start the calibration for thermal conduction.
- Press the **+** key to select the next sensor
- Press the **OK** key to carry out the calibration of the selected measuring channel.
 - The calibration gas concentration is displayed
- Press the **OK** key to confirm the calibration gas concentration or use the **[+]** key to change the calibration gas concentration and complete the process by pressing the **OK** key.
 - The measurement value flashes.

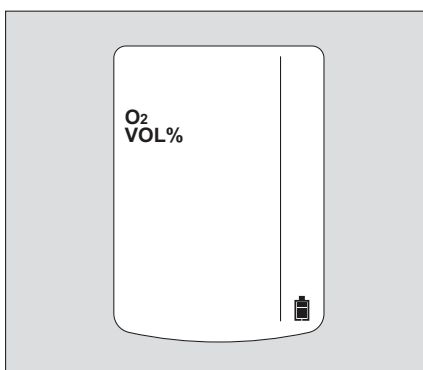

0523996_01_en.eps

- Open the test gas cylinder valve to let test gas flow over the sensor.
- The displayed, flashing measurement value changes to the value according to the supplied test gas.

When the displayed measurement value has stabilized:

- Press the **OK** key to carry out the calibration.
- The display containing the current gas concentration changes with the display » **OK** «.
- Press the **OK** key or wait for approx. 5 seconds to quit the calibration of this measuring channel.
- The next measuring channel appears for calibration.
- After the calibration of the last measuring channel, the device changes to the measuring mode.
- Close the test gas cylinder valve and remove the device from the calibration cradle.

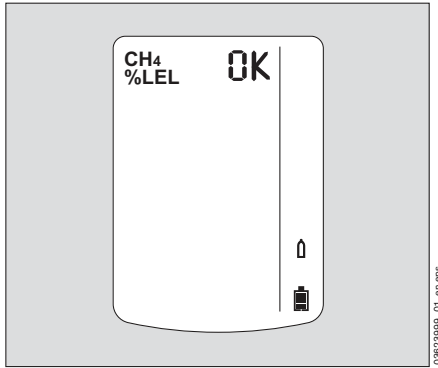

03623999_01_en.esps

If a fault occurred during the sensitivity calibration.

- The fault message » **✖** « appears and » **- -** « is displayed for the respective sensor instead of the measured value.
- In this case, repeat the calibration.
- If necessary, replace the sensor, page 51.

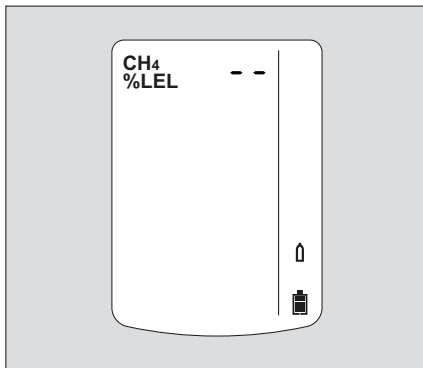

03723999_01_en.esps

Note on adjusting the Ex channel to nonane as the measured gas:

- When calibrating the Ex channel, propane can be used as a substitute for the calibration gas.
- When using propane to adjust the Ex channel to nonane, the display must be set to 2x the test gas concentration used.

Note on the use in underground mining:

- When calibrating the Ex channel to methane as the measured gas, the indication on the instrument must be set to a value 5 % (relative) higher than the test gas concentration used.

Replacing the batteries / rechargeable batteries

⚠ WARNING

Do not replace the batteries / rechargeable batteries in hazardous areas. Danger of explosion!

Batteries / rechargeable batteries are part of the Ex approval. Only the following types may be used:

Alkaline batteries – T4 – (not rechargeable!)

Energizer No. E91, Energizer No. EN91 (Industrial), Varta Type 4106 (power one) or Varta Type 4006 (industrial)

NiMH rechargeable batteries – T3 – (rechargeable)

GP 180AAHC (1800) max. 40 °C ambient temperature.

Switching off the device:

- Press and hold the **OK** key and the **+** key at the same time.
- 1** Loosen the screw (2.0 mm hexagon socket) on the power pack and remove the power pack.
- 2** Replace the alkaline batteries with new ones or the rechargeable NiMH batteries with charged ones – **ensure correct polarity**.
- 3** Completely replace the power pack T4 (with sealed rechargeable batteries, order no. 83 18 704).
- Insert the power pack into the device and tighten the screw, the device switches on automatically.

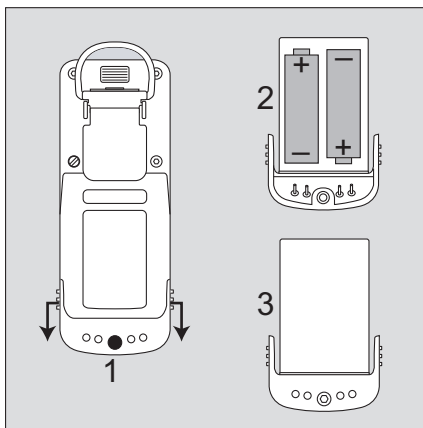

After replacing the power pack T4, it is recommended that a complete charging is carried out.

⚠ WARNING

Do not throw used batteries into fire or try to open them by force. Danger of explosion!

Dispose of the batteries in accordance with local regulations.

After the batteries have been replaced:

- The settings and data are stored when the battery is replaced. The sensors warm up again.

Charging the rechargeable batteries

⚠ WARNING

Do not charge underground or in explosion-hazard areas! Danger of explosion!
The chargers are not designed in accordance with the regulations for firedamp and explosion protection.

Even if the device is not used, we recommend that you store the device in the charger (Charging module X-am 1/2/5000, order no. 83 18 639)!

To maintain the lifetime of the batteries, charging is temperature controlled and only performed in a temperature range of 5 to 35 °C.

When this temperature range is left, the charging process is automatically interrupted and automatically continued after the temperature range has been reached again.

The charging time is typically 4 hours.

A new NiMH power pack reaches its full capacity after three complete charging/ discharging cycles. Never store the device for extended periods without being connected to a power source (maximum of 2 months) because the internal buffer battery will drain.

Charging with the multiple charging station

- A maximum of 20 devices can be charged at the same time on the power pack (order no. 83 18 805) of the multiple charging station.
- When attaching the charging modules, disconnect the power pack from the mains supply!

Attaching charging modules

- 1 Turn the slots of the interlock into a horizontal position by using a screwdriver or coin.
- 2 Insert the projecting tongue of the charging module (at the same time, current entry) until it engages.
- 1 Close the interlock with a quarter turn (slot is positioned vertically).

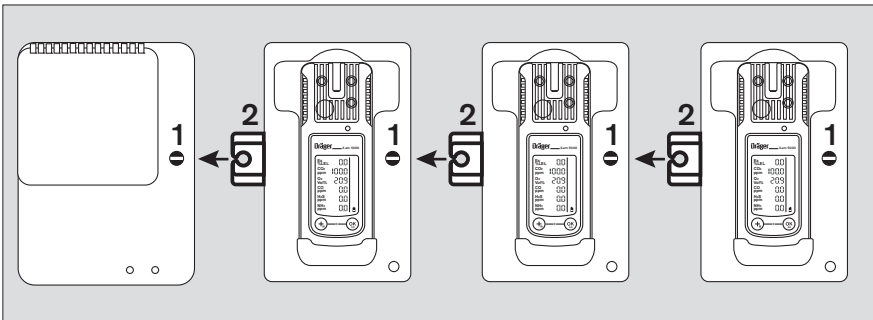

- Attach additional charging modules in the same way.

00723995_01_Lemeps

- Always connect or disconnect the charging modules individually and not in groups in order to prevent the charging station from becoming damaged. During transportation, the power pack and the charging modules should also always be handled individually and without inserted devices.

- Position the device on an even and level surface.

- Connecting the power pack to the mains.

1 The green "Mains" LED lights.

- Insert the device into the charging module.

2 Display LED on the charger:

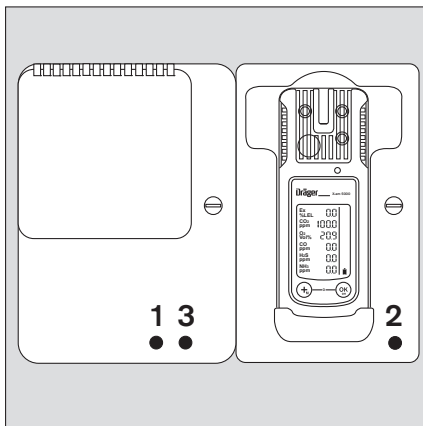
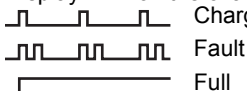

If a fault occurs:

Remove the device from the charging module and insert it again.

If the fault still occurs, have the charging module repaired.

It takes approx. 4 hours to fully charge an empty rechargeable battery.

A short circuit of the charging contacts in the charging modules, e.g., by metallic objects that have fallen in, does not result in damage to the charging station. It should, however, be avoided due to possible heating hazards and incorrect displays on the charging module.

In the event of a short circuit or if the power pack is overloaded:

3 The red "Overload" LED lights, and an audible alarm sounds.

- After the fault has been corrected, the alarm is switched off automatically and the charging process is restarted.
- In the event of a power failure, the devices already charged will be protected from discharging.

018223989_01_en.npa

Charging with charging module and plug-in power pack or vehicle charging adapter

- When using the power pack (order no. 83 16 994), up to 5 devices can be charged at the same time, with power pack (order no. 83 15 635) up to 2 devices.
- The power pack contained in the rechargeable battery and charging set (order no. 83 18 785) is suitable for charging a device.
- When using the vehicle charging adapter (order no. 45 30 057) it is recommended that you supply every charging module separately.

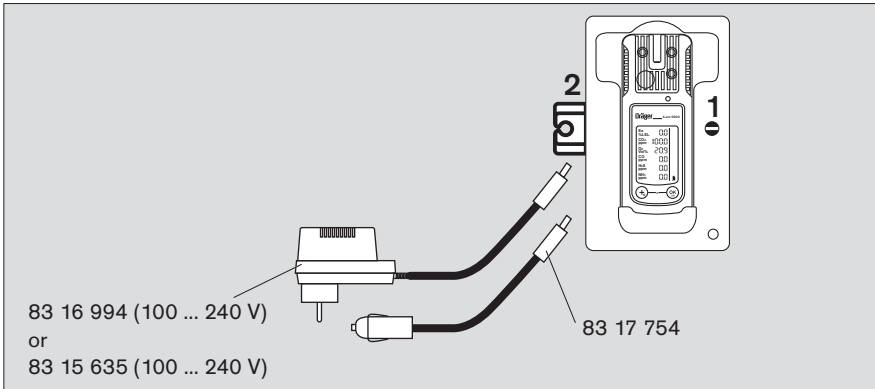

The charging process is carried out analog to charging with the multiple charging station.

Replacing the Sensors

- To replace the sensors of the device, connect the device with a PC.
- Replace the sensors using the PC program Dräger CC Vision.

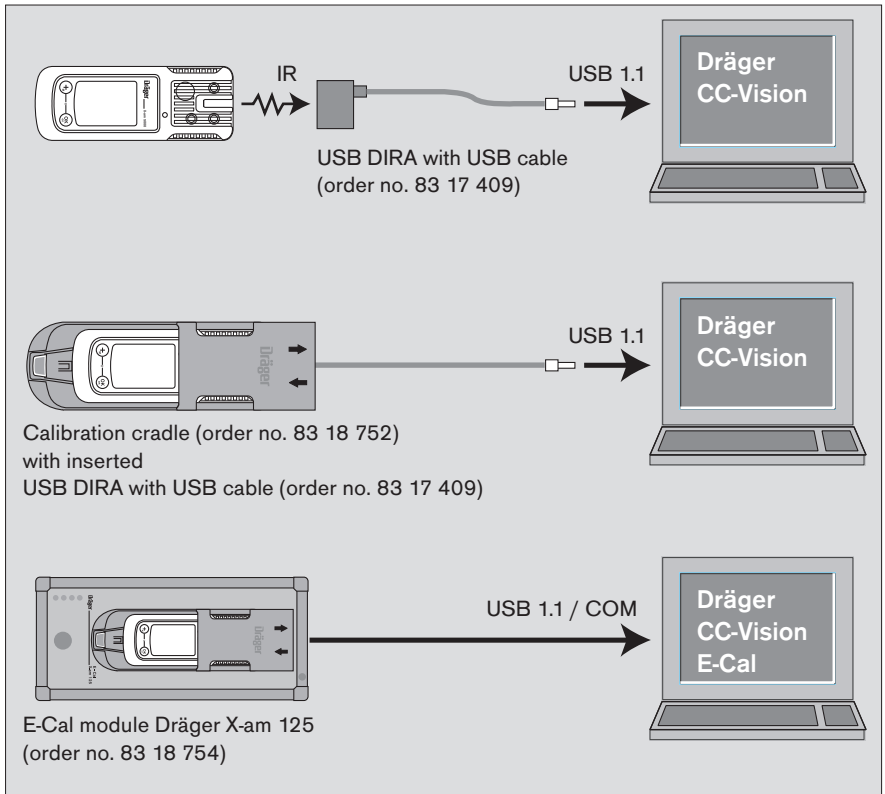

Next:

- Carry out a fresh air calibration, page 39.
and then:
- Calibrate the sensitivity:
either
carry out 1-button calibration, page 41
or
calibrate the sensitivity, page 43.

Electrochemical sensors

 **WARNING**

Do not throw into fire,
Do not force open. Danger! Acid burn risk!
Sensors of type XXS O₃ and XXS NO₂ LC contain small quantities of nanomaterials.



Like batteries, only dispose of as special waste, in accordance with local waste disposal regulations. Further information can be obtained from the relevant local authority and from appropriate waste disposal companies.

The DrägerSensor CatEx 125 PR should be disposed of as electronic waste.

Sensor warm-up acceleration

There is a function available for accelerating the warm-up procedure for selected EC sensors. The function shortens the time taken until the unit is ready to make measurements, i.e. the time taken to save the display and alarm evaluation of the measurements. The time to activate the calibration is not changed.

- In order to use the sensor warm-up acceleration function in the Dräger X-am 5000, at least one sensor suitable for the purpose must be fitted and registered in the unit using the Dräger CC-Vision PC software.
- After that, activate the function by ticking the "Accelerated warm-up" checkbox ("Device" menu) and updating the device data with Dräger CC-Vision.

NOTICE

A selection menu for activating the process will only be displayed after the device is restarted by plugging in a power pack.

- Restart the device by plugging in a power pack.
 - All the display segments, including the visual, audible and vibration alarms, are activated for a short time.
 - The software version is displayed.
 - The instrument performs a self test.
 - The sensor warm-up acceleration menu is displayed.

The steps in the selection menu are limited by a 25-second time-out, which then changes to the standard setting of unaccelerated warm-up and proceeds with the device start-up procedure.

- It is necessary to select between two times for the sensor warm-up acceleration,
 - the shortened time achievable as a result of the warm-up acceleration,
 - the unshortened time required by the installed sensors to save the measurement display (measurement does not flash any more).
- Select the shortened warm-up time with the \oplus button and confirm it with the OK button.
 - The function for entering the password is called up.
- Enter the digits with the \oplus button and confirm with the OK button.



0523959_01.eps

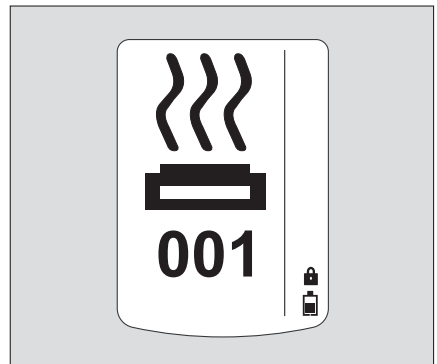

0523959_01.eps

- Start of the warm-up acceleration.
- The remaining time is displayed and decremented.

⚠ WARNING

This function requires that the device is in a gas-free environment. A warning screen is displayed and the remaining time during which no gas may be applied is shown. It is essential to ensure that the sensor is in the fresh air during this time (for approx. 5 minutes)! Any gas applied during this period could later result in faulty alarms or suppressed alarms!



05723995_01.eps

If the procedure is unsuccessful, e.g. as a result of a defective sensor, this will be indicated by error code » X07 « on the channel for the affected sensor (X). In the event of a fault, the device will also switch to the unaccelerated mode.

Dräger recommends that the device not be switched off and on again for a period of two hours when the accelerated warm-up is in use.

Care

The device does not need any special care.

- Dirt and deposits can be removed from the device by washing it with cold water. A sponge can be used for wiping if necessary.

<i>NOTICE</i>

Abrasive cleaning implements (brushes etc.), cleaning agents and cleaning solvents can destroy the dust and water filters.
--

- Carefully dab dry the device using a cloth.

Disposing of the Device



EU-wide regulations for the disposal of electric and electronic appliances which have been defined in the EU Directive 2002/96/EC and in national laws are effective from August 2005 and apply to this device.

Common household appliances can be disposed of using special collecting and recycling facilities. However, as this device has not been registered for household usage, it must not be disposed of through these means. The device can be returned to your national Dräger Sales Organization for disposal. Please do not hesitate to contact the above if you have any further questions on this issue.

Technical Data

X-am 5000

Ambient conditions:	
during operation and storage	-20 to +50 °C (-20 to +40 °C for NiMH single cells type 180AAHC) 700 to 1300 hPa 10 to 90 % (short-term up to 95 %) relative humidity
Device data	
Protection class	IP 67 for devices with sensors
Alarm volume	Typically 90 dB (A) in 30 cm distance
Operation time	
– Alkaline battery	Typically 12 hours under normal conditions
– NiMH rechargeable batteries	Typically 12 hours under normal conditions
Dimensions	approx. 130 mm x 48 mm x 44 mm (H x W x D)
Weight	approx. 220 g to 250 g
CE markings	Electromagnetic compatibility (Directive 2004/108/EC) Explosion protection (Directive 94/9/EC)
Approvals:	see "Tests and Approvals" on page 6.

Sensor Data

Extract! For details refer to data sheets¹⁾ of the sensors used.

	Ex	O ₂	H ₂ S	CO
Measuring principle	Catalytic combustion	Electro-chemical	Electro-chemical	Electro-chemical
Measured value response time $t_{0...90}$ for methane for propane	≤ 17 seconds ≤ 25 seconds	≤ 10 seconds	≤ 15 seconds	≤ 25 seconds
Measured value response time $t_{0...50}$ for methane for nonane	≤ 7 seconds ≤ 40 seconds ²⁾	≤ 6 seconds	≤ 6 seconds	≤ 6 seconds

1) The Instructions for Use/data sheets of the sensors used are supplied with the device on CD. The Instructions for Use/data sheets of the sensors used can also be downloaded from the following Internet address: www.draeger.com

2) For falling concentrations, the settling time for nonane is 50 seconds.

	Ex	O ₂	H ₂ S	CO
Measuring range for methane	0 to 100 %LEL ¹⁾ 0 to 100 vol. %	0 to 25 vol. %	0 to 200 ppm H ₂ S ²⁾	0 to 2000 ppm CO ³⁾
Zero error (EN 45544)	---	---	2 ppm	6 ppm
Device drift	---	---	≤1 % of the measured value/month	≤1 % of the measured value/ month
Warm-up time	35 seconds	≤5 minutes	≤5 minutes	≤5 minutes
Effect of sensor poisons Hydrogen sulfide H ₂ S, 10 ppm	≤1 %LEL/ 8 hours	---	---	---
Halogenated hydrocarbons, heavy metals, gases containing silicone, sulfur or polymerizable substances	Poisoning possible	---	---	---
Measuring accuracy [% of the measured value]	≤5	≤1	≤2	≤2
Standards (Measuring function for explosion protection and measurement of oxygen deficiency and surplus as well as toxic gases, EXAM, Essen, Germany: BVS 08 ATEX G 002 ⁴⁾ , PFG 08 G 001	EN 60079-29-1 ⁴⁾ EN 50271	EN 50104 (Measurement of oxygen deficiency and oxygen surplus) EN 50271	EN 45544-1/-2 ⁵⁾ EN 50271	EN 45544-1/-2 ⁶⁾ EN 50271
Cross Sensitivities ⁷⁾	exist	exist	exist	exist

1) Alkanes from methane to nonane, LEL values according to EN 60079-20-1. At flow speeds of 0 to 6 m/s, the indication may deviate by 5 to 10% of the measured value. When adjusting to propane, the deviation of the indication in air in the range 80 to 120 kPa can be up to 6 %LEL.

2) Certified for 1 to 100 ppm

3) Certified for 3 to 500 ppm

4) The device responds to most combustible gases and vapors. The sensitivities differ depending on the type of gas. We recommend a calibration using the target gas to be measured. For the range of alkanes, the sensitivity decreases from methane to nonane.

5) The measuring signals can be affected additively by sulfur dioxide and nitrogen dioxide and negatively by chlorine.

6) The measuring signals can be affected additively by acetylene, hydrogen and nitrate monoxide.

7) A table of the cross sensitivities is contained in the Instructions for Use or the data sheet of the respective sensor.

Order List

Name and Description	Order No.
<p>Dräger X-am 5000</p> <p>Unlimited 1 to 5 multi gas monitor with exchangeable sensors. With selectable special calibration. Standard calibration of the Ex sensor: Methane. Inclusive to country-specific adjustable standard alarm set-points.</p>	<p>83 20 000</p>
<p>Power supply units:</p> <p>NiMH power pack T4</p> <p>Alkaline power pack T3/T4 (without alkaline batteries) ¹⁾</p> <p>Alkaline batteries T4 (2 pcs) for alkaline power pack</p> <p>Rechargeable battery and charging kit (contains NiMH power pack T4, charging module for Dräger X-am 1/2/5000 and plug-in power pack)</p>	<p>83 18 704</p> <p>83 18 703</p> <p>83 18 708</p> <p>83 18 785</p>
<p>Chargers:</p> <p>Charging module for Dräger X-am 1/2/5000</p> <p>Power pack with connecting cord (worldwide) for a maximum of 20 charging modules Dräger X-am 1/2/5000</p> <p>Plug-in power pack (worldwide) for a maximum of 5 charging modules Dräger X-am 1/2/5000</p> <p>Plug-in power pack (worldwide) for a maximum of 2 charging modules Dräger X-am 1/2/5000</p> <p>Vehicle connecting line 12V/24V for Dräger X-am 1/2/5000 charging module</p> <p>Vehicle installation set for 1 Dräger X-am 1/2/5000 charging module</p>	<p>83 18 639</p> <p>83 15 805</p> <p>83 16 994</p> <p>83 15 635</p> <p>45 30 057</p> <p>83 18 779</p>

1) The alkaline power pack T3/T4 (order no. 83 18 703) is not included in the certificate BVS 08 ATEX G 002 X and PFG 08 G 001.

Name and Description	Order No.
<p>Accessories</p> <p>The accessories are not included in BVS 08 ATEX G 002 X and PFG 08 G 001.</p>	
<p>Pump accessories:</p> <p>Dräger Pump X-am 1/2/5000</p> <p>Case for Dräger Pump X-am 1/2/5000</p> <p>Rubber ball pump</p> <p>Manual pump adapter</p> <p>Dust and water filter</p>	<p>83 19 400</p> <p>83 19 385</p> <p>68 01 933</p> <p>83 19 195</p> <p>83 13 648</p>
<p>Extension hoses and probes:</p> <p>Measuring probe 0.5 m</p> <p>Measuring probe 1.5m</p> <p>Plug-in telescopic probe</p> <p>Telescopic probe 100 with accessories</p> <p>Telescopic probe 150 stainless steel</p> <p>Tester 90</p> <p>Float probe with accessories</p> <p>Viton hose</p> <p>Hose (not suitable for H₂S)</p>	<p>64 08 238</p> <p>64 08 239</p> <p>68 01 954</p> <p>83 16 530</p> <p>83 16 533</p> <p>83 16 532</p> <p>83 18 371</p> <p>12 03 150</p> <p>11 80 681</p>
<p>Accessories for measured value acquisition and configuration:</p> <p>Dräger GasVision</p> <p>Dräger CC Vision</p> <p>PC communication set 1 Dräger X-am 1/2/5000 with USB connection and Dräger CC Vision</p> <p>PC communication set 2 Dräger X-am 1/2/5000 with USB connection, Dräger CC Vision and barcode reader</p> <p>USB DIRA with USB cable (USB infrared adaptor for communication Dräger X-am 1/2/5000 – PC)</p>	<p>83 14 034</p> <p>64 08 515</p> <p>83 18 761</p> <p>83 18 762</p> <p>83 17 409</p>

Name and Description	Order No.
Calibration accessories:	
Bump Test Station, including mixed gas cylinder	83 19 130
Dräger Mobile Printer, for the Bump Test Station	83 19 310
E-Cal module Dräger X-am 1/2/5000	83 18 754
Calibration cradle Dräger X-am 1/2/5000	83 18 752
Mixed gas cylinder 2.5 vol. % CH ₄ , 18 vol. % O ₂ , 15 ppm H ₂ S, 50 ppm CO	68 11 130
Test gas cylinder propane, 0.9 vol. % C ₃ H ₈ in air	68 11 118
On demand controller	83 16 556
Standard controller	68 10 397
Other accessories:	
Rubberboot Dräger X-am 1/2/5X00	83 21 506
Carrying case	83 18 755
Support CD	83 20 056
Spare parts	
DrägerSensor CatEx 125 PR, 0 to 100 %LEL (0 to 100 vol. % methane)	68 11 050
DrägerSensor XXS O ₂ , 0 to 25 vol. % ¹⁾	68 10 881
DrägerSensor XXS O ₂ 100, 0 to 100 vol. %	68 12 385
DrägerSensor XXS CO, 0 to 2000 ppm ¹⁾	68 10 882
DrägerSensor XXS H ₂ S, 0 to 200 ppm ¹⁾	68 10 883
more DrägerSensors	on request ²⁾

- 1) Expected service life of the sensors: O₂, CO and H₂S >5 years, CatEx > 3 years.
2) The data sheets of all the sensors, which can be used for the device, are supplied on CD.
The data sheets can also be downloaded from the following Internet address: www.draeger.com

Declaration of Conformity

Drägersafety

Konformitätserklärung Declaration of Conformity

Wir / We Dräger Safety AG & Co. KGaA
Revalstraße 1
D-23560 Lübeck
Deutschland / Germany

erklären, dass das Produkt / declare that the product

Gasmessgerät Typ **MQG 00xx (X-am 5000)**
Gas Detection Instrument type **MQG 00xx (X-am 5000)**

gemäß den Bestimmungen der Richtlinie 94/9/EG (Geräte und Schutzsysteme zur bestimmungsgemäßen Verwendung in explosionsgefährdeten Bereichen) übereinstimmt mit dem Baumuster der EG-Baumusterprüfbescheinigung

following the provisions of Directive 94/9/EC (Equipment and protective systems intended for use in potentially explosive atmospheres) is in conformity with the type of the EC-type-examination certificates

DEMKO 07 ATEX 143500X

BVS 08 ATEX G 002X

für / for Gerätegruppe und -kategorie / Equipment Group and Category: **I M1 / II 1G, I M2 / II 2G**
Zündschutzart / Type of Protection: **ia, d ia**
Explosionsgruppe / Explosion Group: **I / IIC**
Temperaturklasse / Temperature Class: **T3, T4/T3**
und / and
die Messung brennbarer Gase & Dämpfe gemäß BVS 08 ATEX G 002X /
measurement of combustible, gases & vapours per BVS 08 ATEX G 002X.

ausgestellt von der benannten Stelle / issued by the notified body

UL International DEMKO A/S
Lyskær 8
DK-2730 Herlev
Kenn-Nr. / ident. no. 0539

DEKRA EXAM GmbH
Dinnendahlstraße 9
D-44809 Bochum
Kenn-Nr. / ident. no. 0158.

Das Produkt wurde unter einem Qualitätssicherungssystem hergestellt, endabgenommen und geprüft, das zugelassen wurde von der benannten Stelle

The product has been manufactured, finally inspected and tested under a quality system which has been approved by the notified body

DEKRA EXAM GmbH
Dinnendahlstraße 9
D-44809 Bochum
Kenn-Nr. / ident. No. 0158.

Ralf Drews
Research & Development
Dräger Safety AG & Co. KGaA

Lübeck, 26.06.2008

Dokument-Nr. / document no.: SE20588 "02"
Seite 1 von 1 / page 1 of 1

P. V. *Benjamin*

Dräger Safety AG & Co. KGaA

Revalstraße 1

D-23560 Lübeck

Germany

Phone +49 451 8 82- 0

Fax +49 451 8 82- 20 80

www.draeger.com

90 23 999 - TM 4638.210 en

© Dräger Safety AG & Co. KGaA

Edition 10 - August 2012

(Edition 01 - April 2007)

Subject to alteration